

# Strategies for Optimizing the Mobile Phase in Planar Chromatography

DAVID NUROK

Department of Chemistry, Indiana University-Purdue University at Indianapolis, Indianapolis, Indiana 46223

Received September 27, 1988 (Revised Manuscript Received December 21, 1988)

## Contents

I. Introduction	363
A. Scope of the Review	363
B. Differences between Planar Chromatography and HPLC	363
C. Resolution and Spot Separation in Planar Chromatography	364
D. Solvent Strength and Selectivity	366
1. The Parameter $\epsilon^{\circ}$	366
2. The Parameter $P'$	366
II. Strategies for Optimizing Separation in One-Dimensional Planar Chromatography	367
A. Simple Methods	367
B. More Sophisticated Approaches	368
1. Window Diagrams	368
2. The Sequential Simplex Method	368
3. The Mixture Design Statistical Approach	369
4. The Prisma Method	370
III. Strategies for Optimizing Separation in Two-Dimensional Planar Chromatography	372
A. Introduction	372
B. Conventional Computational Approaches	372
C. The Statistical Approach	374

## I. Introduction

### A. Scope of the Review

This review on optimizing the mobile phase in planar chromatography deals with both classical thin-layer chromatography (TLC) and the newer technique of overpressured layer chromatography (OPLC), where the solvent is pumped through the chromatographic layer. Paper chromatography is not considered as the technique has been superseded by TLC, even though a few reports on its use continue to appear.

In planar chromatography some form of optimization is generally necessary if complete separation of all components in a sample is required and if the number of these is larger than a small fraction of the spot capacity of the system. While it is the physical characteristics of the layer and the type of development technique used that determine the spot capacity, it is the selection of the solvent system that determines how effectively this capacity is utilized for a given analysis. This review is restricted to the use of isocratic solvent systems, which is an area where a critical evaluation of strategy appears timely. The use of gradient solvent systems and multiple development techniques are not included; these techniques represent only a small fraction of reported separations in planar chromatography, and while the techniques do have advantages for certain separations, their use is well described in modern textbooks.<sup>1-4</sup>

The practitioner of planar chromatography is fortunate because the methods for optimizing an isocratic

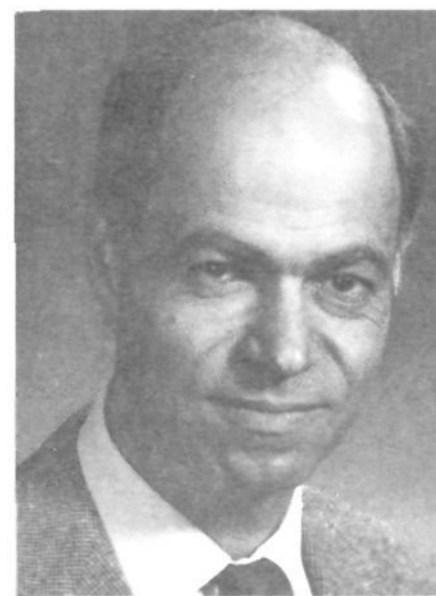

David Nurok was born in Cape Town, South Africa, and obtained his Ph.D from the University of Cape Town in 1967. He worked for 9 years in industrial research positions in South Africa, first at AE&CI in Johannesburg and then at the Sugar Milling Research Institute in Durban. He then spent 2 years as a postdoctoral associate with Professor Albert Zlatkis at the University of Houston. Since 1978 he has been an Associate Professor in the Department of Chemistry at Indiana University-Purdue University at Indianapolis. His current research interests include solvent selectivity in liquid chromatography and the computer-assisted optimization of two-dimensional planar chromatography.

solvent system in HPLC are generally applicable with only minor modification to planar chromatography. Thus this review covers strategies for optimizing solvent composition that either have been specifically developed for or have already been applied to planar chromatography as well as those techniques, developed for HPLC, that have an obvious potential for use in planar chromatography.

### B. Differences between Planar Chromatography and HPLC

Planar chromatography may also be used for scouting a suitable solvent for separation by HPLC; the topic is discussed in detail in the textbook by Geiss.<sup>5</sup> While the overall partition mechanism of solute between stationary and mobile phase is very similar in the two techniques, there are nevertheless some important differences that need to be noted. In planar chromatography (excluding the continuous-development mode) the solvent front migrates only to the end of the TLC plate, with the result that all solutes remain on the layer, whereas in HPLC all are eluted from the column before detection. This results in different solvent strength requirements for the two techniques. The term "TLC plate" is used with respect to both TLC and OPLC in this review. The second difference is that, in contrast to isocratic HPLC, solvent gradients always occur in planar chromatography, even when a pure solvent is used as the mobile phase. This occurs because the

solvent front moves more rapidly than the bulk of the solvent and causes a gradient in the phase ratio. This can be illustrated by plotting the phase ratio against  $z$ , the distance along the TLC plate. The shape of such a plot will vary with  $z_f$ , the distance migrated by the solvent front. Giddings and coauthors<sup>6</sup> demonstrated that if the phase ratio is plotted against the "reduced distance", which is defined as  $z/z_f$ , a single plot is obtained irrespective of the distance migrated by the solvent front. This work was actually performed with paper chromatography but similar results have subsequently been found for TLC.<sup>7</sup> As pointed out by Brenner and coauthors,<sup>8</sup> it follows that, provided the solute and solvent have the same starting position, the solute will have a constant  $R_f$  and will encounter an unchanged phase ratio throughout the chromatographic process. The value of this ratio will depend on the  $R_f$  of the solute. In practical TLC, the solute is usually spotted a distance  $z_0$  from the point of solvent introduction. This will however cause little variation in the  $R_f$  values provided the ratio  $z_f/z_0$  is large. Gradients do not occur in HPLC because an equilibrated column is used in contrast to the dry bed used in planar chromatography. The third difference between planar chromatography and HPLC, like the second difference, results from the nonequilibrated mode of operation in planar chromatography and is referred to as solvent demixing. This occurs when the mobile phase consists of a mixture of solvents of substantially different polarity and the stationary phase is a polar material such as silica gel. The more polar solvent is preferentially adsorbed with a corresponding depletion of this component from the mobile phase. In extreme cases this results in secondary, and even tertiary, solvent fronts. In some cases a solute will travel within the secondary front as an extremely sharp spot. The solvent between two fronts may be treated in optimization studies as being essentially homogeneous, notwithstanding the gradients referred to above. The composition of the mobile phases on either side of a secondary front is very different and must be treated as such in any optimization study. The fourth difference between TLC and HPLC is due to the former technique using an open bed that is in contact with solvent vapor. In this respect there is no difference between OPLC and HPLC. The amount of solvent vapor in the development chamber atmosphere may be reasonably well controlled by the use of a filter paper pad saturated with the development solvent. The presence of solvent vapor can have a significant effect on the chromatography; demixing can be minimized by preadsorption of the polar solvent, and evaporation from the layer surface is reduced due to the partial pressure of solvent vapor. This evaporation affects the volume of solvent flowing through the layer for a given migration of the solvent front and hence affects  $R_f$  values. A recent review covers the effect of vapor saturation.<sup>9</sup> While the above differences affect the transfer of solvent systems between planar chromatography and HPLC, these do not interfere with the transfer of the strategies of solvent optimization.

### C. Resolution and Spot Separation in Planar Chromatography

The following equation predicts resolution as a function of  $N$ , the number of theoretical plates avail-

able, and  $k_1$  and  $k_2$ , the capacity factors of neighboring peaks, and may be used in either HPLC or gas chromatography

$$R_s = \frac{N^{1/2}}{4} \left( \frac{\alpha - 1}{\alpha} \right) \left( \frac{k_2}{1 + k_2} \right) \quad (1)$$

where  $k_2$  is the larger of the capacity factors and  $\alpha$ , the separation factor, given by the ratio of the two distribution coefficients or the two capacity factors, is determined by the selectivity of the separation system. A more exact form of the equation is

$$R_s = \frac{N^{1/2}}{2} \left( \frac{k_2 - k_1}{2 + k_1 + k_2} \right) \quad (2)$$

There are several empirical approaches to predicting capacity factor as a function of solvent composition (see ref 10 and this review), and this allows peak resolution to be predicted as a function of solvent composition if it is assumed—usually correctly in HPLC—that the number of theoretical plates does not change substantially with solvent composition. A similar situation is expected to hold in OPLC, where the flow rate, and hence the number of theoretical plates per unit distance traversed by a solute, remains constant throughout a chromatographic run. There is however an important difference; in column chromatography all solutes traverse the entire column, whereas in planar chromatography the length of the layer traversed is determined by the  $R_f$  of each solute, which results in each solute experiencing a number of theoretical plates that is related to its  $R_f$  value. Snyder<sup>11</sup> has suggested that the number of theoretical plates be approximated by  $(NR_{f,1})^{1/2}$ , where  $N$  corresponds to the number of theoretical plates that would be experienced if the solutes were to migrate to the end of the layer and  $R_{f,1}$  is the value of the faster migrating solute. The resolution equation proposed by Snyder is

$$R_s = 1/4(NR_{f,1})^{1/2}(\alpha - 1)(1 - R_{f,1}) \quad (3)$$

Equations to describe planar chromatography can be written in terms of either  $R_f$  or  $k$ , with the former parameter being the more widely used. The equations (with the exception of eq 3 and 13) in this review are written in terms of capacity factor in order to emphasize similarities between planar chromatography and column chromatography. The relationship between  $R_f$  and capacity factor is

$$R_f = \frac{1}{1 + k} \quad (4)$$

Thus eq 3 can be written as

$$R_s = \frac{1}{4} \left( \frac{N}{1 + k_1} \right)^{1/2} \left( \frac{k_2}{k_1} - 1 \right) \left( \frac{k_1}{1 + k_1} \right) \quad (5)$$

Both eq 3 and 5 show that the efficiency of a system, as given by the number of theoretical plates, must be increased by a factor of 4 in order to double resolution and that resolution is very low at either very high values of capacity factor (low  $R_f$ ) or very low values of capacity factor (high  $R_f$ ). Both equations are expected to give a good approximation of resolution in OPLC, where, as

noted above, the rate of solvent migration is independent of the distance migrated by the solvent front.

In TLC, but not in OPLC, there is a severe limit to the degree that resolution can be increased through an increase in the number of theoretical plates obtained by using a longer TLC plate. In practice, the maximum usable plate length is between 10 and 20 cm, depending on the particle size. Guiochon and coauthors<sup>12</sup> have shown that for a very long development time, both the migration distance and the spot size increase in proportion to the square root of time, with the result that the chromatogram then expands without any increase in resolution. These authors have shown that there is in fact a maximum number of theoretical plates that can be achieved by increasing the TLC plate length. This is due to the inherent limitation that surface tension is the driving force for solvent flow in TLC.

The relationship between  $z_f$ , the distance migrated by the solvent front in TLC, and  $t$ , the time in seconds for this development, is approximated by

$$z_f^2 = \kappa t \quad (6)$$

where  $\kappa$  is the solvent velocity constant. Differentiation and rearrangement give

$$u_f = \kappa / (2z_f) \quad (7)$$

where  $u_f$ , the rate of migration of the solvent front, is seen to be inversely proportional to the distance migrated.

Guiochon and Siouffi<sup>13</sup> have discussed how the velocity constant is related to experimental parameters and have shown that a significant correction should be applied to eq 6 for developments exceeding a few minutes. This is more important for thin than for thick stationary layers and in a saturated chamber is due to both adsorption of solvent vapor onto and the evaporation of solvent from the stationary layer, with the former effect being more important than the latter.

The number of theoretical plates changes throughout a TLC development due to the variation of flow rate with distance migrated. Moreover, changes in flow rate will occur with any change in solvent composition due to changes in solvent viscosity and surface tension. For these reasons  $N$  is not a constant and resolution as predicted by equations such as eq 3 and 5 has not been used in the optimization of solvent systems for TLC. In its place spot separation (center to center) or a criterion dependent on spot separation has been used, and while, for many systems, this can be accurately predicted as a function of solvent composition, it does not take into account the spot size and hence spot resolution. The final spot size is dependent on several parameters, including the initial spot size, the  $R_f$  of the solute and its diffusion coefficient in the mobile phase, the physical characteristics of the stationary layer and of the mobile phase, and the path length used for development. The center to center spot separation required must be estimated from an analyst's experience with the particular planar chromatographic system used.

While TLC resolution between a pair of neighboring compounds cannot be accurately predicted by using an equation such as eq 3 or 5, it can be estimated in a given chromatogram by dividing the distance between a pair of spots by the average spot width at half-height. Al-

ternatively, the separation number, which defines the maximum number of equally spaced solutes that can be separated in a planar chromatographic system, can be calculated by measuring spot widths in an actual chromatogram using either an approximate<sup>14</sup> or an exact formula.<sup>15</sup> Such measures of separation quality should be satisfactory when either the simplex or the statistical mixture design methods discussed in this review are used.

Several authors<sup>16-18</sup> have suggested that maximum resolution occurs at an  $R_f$  value of 0.3, with this value being obtained by differentiating resolution with respect to  $R_f$  at a constant value of  $\alpha$  in eq 3. This implies that it is possible to change the solvent strength of a system—and hence  $R_f$ —while maintaining a constant selectivity (i.e., a constant  $\alpha$ ). Perry<sup>19</sup> has pointed out that this assumption does not follow from theory and is unduly restrictive. While this assumption is certainly true for some systems, in Perry's view the majority of systems do not follow this behavior. This is illustrated by using the following linear relationship, which, in a slightly different form— $R_M$ , which is equivalent to  $\log k$ , was originally used—is due to Soczewinski<sup>20</sup> (but which also may be considered a simplified form of an equation due to Snyder as discussed by Jandera and Churáček<sup>21</sup>) and which applies to many binary solvent systems consisting of a mixture of a strong and weak solvent

$$\log k = a \log X_s + b \quad (8)$$

where  $X_s$  is the mole fraction of the strong solvent and  $a$  and  $b$  are constants that need to be determined experimentally for each solute. Conditions where this linear relationship breaks down are discussed in ref 22. A plot of  $\log k$  vs  $\log X_s$  will yield a set of parallel lines, each corresponding to a solute, in a system where selectivity, given by the ratio of any two capacity factors, remains constant with changing solvent strength. While such systems do exist—e.g., some of the plots in ref 22 include parallel lines—other systems are also found. Thus Perry quotes Soczewinski and coauthors:<sup>23</sup> "Most  $R_M$  vs  $\log X_s$  (i.e.,  $\log k$  vs  $\log X_s$ ) plots spread fanwise with the dilution of the polar solvent—the selectivity of separation is thus generally higher for lower values of  $X_s$ . There are also exceptions—(where) the plots spread in the opposite direction." Perry concludes that the selectivity of pure solvents can be increased by diluting with a low-strength solvent; the resulting low  $R_f$  values (which decrease exponentially with decreasing solvent strength) are compensated for by performing TLC in the continuous-development mode, whereby solvent is allowed to evaporate from the end of the TLC plate until the spots have migrated a sufficient distance to yield a desired separation. If a short path length is used, analysis time "need take no longer than usual and there is in addition a bonus" because concentrated, easily detected spots are obtained as illustrated with examples in the paper. Nurok and coauthors<sup>24</sup> have shown that it is possible to predict an optimum combination of solvent composition and plate length in continuous-development TLC, which will yield a predicted spot separation in a minimum analysis time, which for low  $R_f$  compounds is substantially less than the analysis time with conventional development; deviation from the optimum combination however can lead to a long analysis time. This approach has been

successful for the normal-phase separation of steroids on silica gel layers<sup>25-27</sup> but was not successful for separating dansyl amino acids on a C<sub>18</sub> layer using aqueous solvents.<sup>28</sup>

#### D. Solvent Strength and Selectivity

Solvent strength refers to the ability of a solvent or solvent system to elute a solute; it increases with solvent polarity in normal-phase chromatography and decreases with solvent polarity in reversed-phase chromatography. Solvent selectivity may be defined as the ability of a particular solvent system to separate a pair of compounds that are not separated in other systems or alternatively may be defined as the ability of a solvent system to separate two compounds where the polarities of the two compounds are not obviously different—the latter definition being due to Snyder.<sup>29</sup> The value of  $\alpha$ , the separation factor, may be used as a quantitative measure of solvent selectivity.

The most widely used parameters of solvent strength are  $\epsilon^\circ$  for adsorption chromatography and  $P'$  for partition chromatography. Other parameters that have been considered for chromatography include  $\delta$ , Hildebrand's solubility parameters,<sup>30</sup>  $E_T$ , the solvatochromic parameter,<sup>31</sup> and  $\pi^*$ , the polarizability-dipolarity parameter.<sup>32</sup>

The strength and selectivity of a solvent system are often treated as independent variables; the optimum strength is first found, usually by diluting a strong solvent with a weak solvent, and optimum separation is then effected by substituting other solvents or solvent systems of the same strength but of different selectivity. This approach is useful for separating complex mixtures and ensures that the separation capacity of the entire TLC plate can be used. It should however be noted that strength and selectivity are often related, in which case the separation of simple mixtures can be optimized by diluting a strong solvent with a weak solvent.

##### 1. The Parameter $\epsilon^\circ$

$\epsilon^\circ$  has been defined by Snyder<sup>33</sup> as "the adsorption energy of the solvent per unit area of a standard activity surface". It is discussed in detail in ref 33; briefer, but adequate, discussions may be found in modern textbooks such as those by Geiss<sup>34</sup> or Schoemakers.<sup>35</sup> Snyder<sup>36</sup> has derived an equation that quantitatively predicts  $\epsilon^\circ_{AB}$ , the strength of a binary mixture of a weak and moderately strong solvent. This equation predicts that the addition of even a small quantity of a stronger solvent to a weak solvent will have a substantial effect on the strength of the mixture while the effect of incremental additions at higher concentrations of the stronger solvent is less pronounced. Snyder and Glajch<sup>37,38</sup> have reported on methods that allow solvent strength to be calculated for binary mixtures containing a more polar strong solvent as well as for ternary and quaternary mixtures.

An equation that is relevant to the practical optimization of separation in planar chromatography using binary solvent systems is eq 9, which is a simplification of an equation due to Snyder.<sup>39</sup>

$$\log k = a + b\epsilon^\circ_{AB} \quad (9)$$

where  $a$  and  $b$  are empirically determined constants and  $\epsilon^\circ_{AB}$  is as defined above.

##### 2. The Parameter $P'$

Snyder<sup>40,41</sup> has derived the  $P'$  polarity index based on the individual gas-liquid distribution coefficient of ethanol, dioxane, and nitromethane in a large number of solvents as determined by Rohrschneider.<sup>42</sup> Subscripts e, d, and n used in this discussion refer to these three compounds. A constant,  $\log K_g''$ , is derived for each of these test solutes and is proportional to the energy of interaction of the solute with a given solvent. Correction is made for the molar volume of both the solute and the solvent. Implicit in the derivation is the correction for dispersion forces by assuming that all test solutes have the same polarizability as *n*-octane. With reference to the latter, it should be noted that Poppe and Slaats<sup>43</sup> have written that "the scheme developed by Snyder...appears very promising...(but) the elimination of the nonpolar contributions...is the weak point".

$P'$  is defined as the sum of the  $\log K_g''$  values for each of the three test solutes.  $x_e$ ,  $x_d$ , and  $x_n$  are selectivity parameters that reflect the "relative ability of a solvent to function respectively as a proton acceptor, a proton donor, or a strong dipole interactor"<sup>40</sup> and are defined by dividing the corresponding  $\log K_g''$  values by  $P'$ . Solvents can be divided into eight groups by plotting the respective values of  $x_e$ ,  $x_d$ , and  $x_n$  on triangular axes, and it is assumed that, within each group, solvents are equivalent in selectivity. Groups furthest from each other in the triangular plot are assumed to exhibit the greatest difference in selectivity.

Snyder<sup>41</sup> has written that "while there are a large number of solvents that can be used for this purpose (i.e., controlling selectivity), the use of three properly chosen polar solvents plus some nonpolar diluent should provide almost all of the selectivity available from the complete list of solvents of known selectivity". Snyder suggested that if only dipolar, proton-donor, and proton-acceptor interactions are important, the short list would include ethyl ether (group I), methylene chloride (group V), and chloroform (group VIII) with either hexane or carbon tetrachloride as a nonpolar diluent. These three solvents are expected to have substantial differences in selectivity because they are from groups closest to the apices of the selectivity triangle. A more recent classification referring to the same selectivity triangle suggests either methyl *tert*-butyl ether, chloroform, and methylene chloride<sup>44</sup> or methyl *tert*-butyl ether, acetonitrile, and methylene chloride<sup>45</sup> as selective solvents in normal-phase chromatography. The former selection is based entirely on the selectivity triangle, whereas the latter uses solvent localization as an additional selectivity criterion, with two of the solvents being localizing but of different basicities and the third being a nonlocalizing solvent. Solvent localization<sup>46,47</sup> refers to a strong solvent adsorbing in a particular configuration on silica with a presumed strong interaction between the polar functionality of the solvent and surface silanol groups. The three solvents<sup>48</sup> that are widely used as aqueous mixtures for adjusting selectivity in reversed-phase chromatography are aqueous mixtures of methanol, tetrahydrofuran, and acetonitrile. Snyder<sup>41</sup> has suggested that for reversed-phase separations, where aqueous mixtures are used, the classification into selectivity groups may be useful but that other factors "will surely play a major role".

The assignment of the discussed function to  $x_e$ ,  $x_d$ , and  $x_n$  is somewhat approximate. Ethanol not only is a proton donor, and hence a probe for proton-acceptor properties, but is also a compound with substantial proton-acceptor properties.<sup>49</sup> Nitromethane would be expected not only to exhibit dipolar interactions but also to act as a hydrogen-bond acceptor. Presumably for these reasons Snyder noted that the scheme "is useful but not precise".<sup>40</sup> Virtually every modern text on chromatography has included this eight-group classification scheme, without indicating that the accuracy of the classification has not been tested. The only dissident reports are by Lewis and coauthors,<sup>50</sup> working with polystyrene oligomers, and by West,<sup>51</sup> working with steroids; both groups reported that the solvent triangle does not accurately predict selectivity for the particular separations studied.

For the above reasons the author has reservations about the identity and number of selectivity groups assigned. However, regardless of whether these reservations are valid or not, the concept of dividing solvents into selectivity classes is indeed most interesting, and there appears a need to test this concept and, if it is found correct, then either to confirm the present assignment or to reassign solvents to different groups.

The parameter  $P'$  should strictly be used only for nonaqueous systems; the parameter  $S$ , derived by an empirical method,<sup>52</sup> should be used with aqueous systems. Either parameters may be used to predict the strength of a mixture of solvents A and B:

$$P' = \phi_A P_A + \phi_B P_B \quad (10)$$

where  $\phi_A + \phi_B = 1$ . An equation using the parameter  $S$  and of the same form as eq 10 can be used for predicting the strength of aqueous solvents.

In normal-phase separations a hydrocarbon such as hexane ( $P' = 0.1$ ) is recommended as the weak solvent; in reversed phase separations the weak solvent is always water ( $S = 0$ ). If the original solvent system does not separate the mixture, the selectivity can be adjusted by substituting a solvent from a different selectivity group for the strong solvent. Because the contribution to solvent strength of the weak solvent is (virtually) zero, the overall strength can be maintained by having the volume fraction of the new strong solvent be

$$\phi_C = (\phi_B P_B) / P_C \quad (11)$$

The same procedure applies to aqueous solutions using the parameter  $S$ . It should be noted that these equations may not be correct for solvents that interact strongly with water. Thus Dorsey and coauthors<sup>31</sup> have noted that eq 10 involves a "poor assumption for reversed phase mobile phases as neither water nor methanol form ideal solutions in Hildebrand's sense".

## II. Strategies for Optimizing Separation in One-Dimensional Planar Chromatography

### A. Simple Methods

Selection of an appropriate solvent system will enable virtually any mixture of solutes to be separated, provided that the spot capacity of the planar chromatographic system is large enough. Thus solvent selection may be considered the most important component of an optimization strategy and indeed is often the only component seriously considered.

An intuitive, trial and error approach to solvent selection is often acceptable when mixtures containing only a small number of components are to be separated. A list of solvents of increasing strength such as that published by Halpaap<sup>53</sup> for normal-phase chromatography is of use in selecting solvents that can be used either as single components or as mixtures; a more extensive list is available in ref 54. In reversed-phase planar chromatography the most commonly used solvents are acetonitrile, methanol, and tetrahydrofuran used alone or as mixtures and always used in the aqueous form. Solvent pH may be controlled with a suitable buffer for separation of either acidic or basic solutes by reversed-phase planar chromatography.<sup>55</sup> A large number of solvent systems can be screened in a few hours, with the major limitation being the number of developing chambers available. The nature of the chambers used for preliminary screening varies in sophistication from a beaker covered with a watch glass to apparatus specifically designed for this purpose.

An interesting device for the rapid screening of solvent mixtures is due to Rippahn and Halpaap<sup>56</sup> and utilizes circular planar chromatography. Three different solvent systems are simultaneously fed to the planar chromatographic layer at three inlets uniformly spaced around the center of the plate. This results in a solvent gradient that varies across the entire plate and that generates a very irregular chromatogram with substantial variation in the spacing of neighboring bands around the plate for a sample that is applied as a circle around the inlets. The solvent composition that results in the maximum separation can be estimated from the angular sector of the TLC layer in which it occurs.

Another example of a device for the rapid screening of solvent systems is the Camag Vario KS chamber, which allows for the simultaneous evaluation of either six or ten solvent systems, depending on whether a conventional TLC or HPTLC plate is used, by allowing each of these to migrate along parallel channels scored on a single TLC plate. An available option has the plate lying face down with each channel over an individual well that may be filled with the development solvent or with an appropriate concentration of aqueous sulfuric acid in order to further optimize the separation (in the case of silica and other polar layers) by controlling the relative humidity.

A structured approach using the Vario KS chamber has been suggested by Geiss,<sup>57</sup> the same approach can be used with conventional chambers albeit with less convenience. Three strong solvents—methyl *tert*-butyl ether, acetonitrile, and methanol—are used on the basis of differences in selectivity. Each of the three strong solvents is diluted with an appropriate concentration of a weak solvent to yield a series of solutions spanning the  $\epsilon^\circ$  range from 0.00 to 0.70 in increments of 0.05 $\epsilon^\circ$ . This covers the solvent strengths required for separating solutes ranging from low to very high polarity on a silica gel layer. Runs are then performed with these solvents to determine which is of the correct strength for separating a given solute mixture. Once this strength is identified, fine tuning is accomplished by blending solvent mixtures of this strength but of different selectivity to yield a solvent system of different selectivity but of approximately the same strength. The strengths of three other diluted solvents are also listed in this

reference. This approach assumes that selectivity and solvent strength are independent variables, which, as noted earlier in this review, is not necessarily a correct assumption. In spite of this reservation, this appears an attractive practical method that should often yield a satisfactory separation.

The above method may be considered a modification of a graphical approach for which data have been published by Saunders.<sup>58</sup>  $\epsilon^\circ$  values are computed for several binary solvent systems and each is represented by a straight line with a volume fraction scale, which allows reading solvent strength at any composition against an  $\epsilon^\circ$  scale. Once the correct solvent strength is found for one of the binary systems, other binaries of the same strength are identified by inspection of the diagram.

## B. More Sophisticated Approaches

Solvent selection based on experience and chromatographic intuition is suitable for the separation of very simple mixtures but can be very time-consuming when applied to complex mixtures where a more systematic strategy should be used.

### 1. Window Diagrams

Window diagrams have been widely used both in gas chromatography and in HPLC but have hardly been used in planar chromatography. In the only reports<sup>59,60</sup> on their use,  $\Delta R_f$  was used as the separation parameter that was plotted against solvent composition.  $\Delta R_f$  between a pair of solutes 1 and 2 is related to the corresponding capacity factors:

$$\Delta R_f = \frac{k_2 - k_1}{(1 + k_1)(1 + k_2)} \quad (12)$$

The values of  $k_1$  and  $k_2$  can be calculated as a function of the composition of a binary solvent by using either eq 8 or 9 and a plot of  $\Delta R_f$  vs solvent composition (represented by either  $X_s$  or  $\epsilon^\circ_{AB}$ ) can be constructed. If all solute pairs are considered, the plot represents a window diagram that identifies the optimum solvent composition. Such a diagram is shown in Figure 1 for the separation of five phenols on a polyamide layer using acetone/cyclohexane as solvent. The diagram shows that this system is unsuitable for TLC because the maximum value of  $\Delta R_f$  for two of the pairs is  $<0.05$ ; below this value separation becomes very difficult and often impossible.<sup>12</sup> The separation of at least one of the latter pairs, and all other pairs, should be possible by OPLC with a high-performance plate and an acetone mole fraction of about 0.45. If there is no inversion of elution order, as in Figure 1, then only neighboring pairs need be considered. It should however be noted that, when a simple mixture of solutes is separated, the trial and error optimization of the composition of a binary solvent system can be as effective as the construction of a window diagram.

The above approach has been used to define a parameter that has potential for measuring the strength of binary solvent systems. When all solute pairs in a mixture are considered, it is found that the values of  $(\Delta R_f)_{\max}$ , the maximum values of  $\Delta R_f$ , tend to cluster around a particular mole fraction of the binary solvent system. This composition is referred to as the cluster center of the binary system. If a series of binary sol-

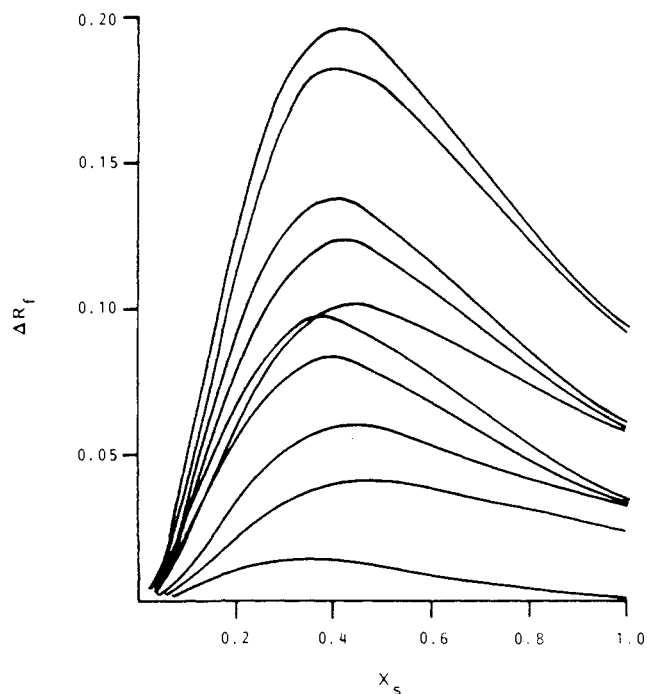

**Figure 1.** Plot of  $\Delta R_f$  vs mole fraction for the separation of five phenols on a polyamide TLC plate using acetone/cyclohexane as solvent. The ten curves represent all the paired combinations of phenol, *o*-cresol, *p*-cresol, 2,3-xyleneol, and 3,4-xyleneol. Calculation of  $\Delta R_f$  is based on data from ref 22. Reprinted with permission from ref 60; copyright 1982 Hüthig Verlag GmbH.

vents are prepared by using a fixed A solvent and varying the identity of the B solvent, it is found that the values of the cluster center correlate well with the strength of these solvent systems.<sup>60</sup> More recently, it has been found that there is an excellent correlation between the actual  $R_f$  values of either steroids or esters of dansyl amino acids and cluster center values for binary solvent systems consisting of a strong solvent at a fixed mole fraction and each of a series of weaker solvents.<sup>61</sup>

A system consisting of three or more solvents allows a large variety of intermolecular interactions and, when optimized, would be expected to yield a better separation than that attainable in a binary mixture of solvents. This is usually the case even though there are reports of such systems (see, e.g., ref 62) that at the optimum composition are reduced to a binary solvent system; i.e., one or more of the possible components is not present in the optimum composition.

The approaches that have been used for optimizing such systems are the simplex algorithm, the mixture design statistical approach, or the prisma approach. These are discussed below.

### 2. The Sequential Simplex Method

The sequential simplex approach can be used to optimize parameters in a wide number of applications in analytical chemistry,<sup>63</sup> including the optimization of solvent composition in planar chromatography;<sup>64-66</sup> it has been described<sup>67</sup> as a "hill-climbing algorithm that moves a pattern of experimental points away from regions of worse response towards convergence on an optimum in the response surface". The concentrations of the components of a solvent system are varied between runs according to a structured and interactive algorithm such that the overall separation approaches

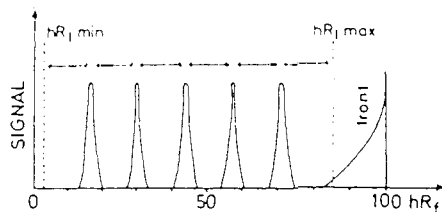

**Figure 2.** Ideal distribution of  $hR_f$  values, with the dotted lines showing the chosen boundaries. Reprinted with permission from ref 66; copyright 1987 American Chemical Society.

an optimum value after a number of successive chromatographic runs. The system optimized should not involve reversal of elution order because, as Deming and coauthors<sup>68</sup> have noted, there is no guarantee for such systems that the optimum obtained is global rather than local. The above three references in planar chromatography describe somewhat different forms of the simplex algorithm and use different response variables, of which that due to De Spiegeleer and coauthors<sup>66</sup> is the most sophisticated and is given by the following function:

$$\left\{ \frac{(hR_f(\max) - hR_f(n))(hR_f(l) - hR_f(\min)) \prod_{i=1}^{n-1} (hR_f(i) + 1 - hR_f(i))}{(hR_f(\max) - hR_f(\min)) / (n + 1)^{n+1}} \right\} \times 100\% \quad (13)$$

$hR_f$  is defined as  $R_f \times 100$ , and  $hR_f(\max)$  and  $hR_f(\min)$  are the boundaries within which the spots must lie. There are  $n$  components in the mixture, with  $l$  being the component of lowest  $R_f$  and  $n$  being the component of highest  $R_f$ . When all components are ideally spaced, as in Figure 2, the function has a value of 100%. It was used as the dependent variable (i.e., the response) in the simplex optimization of a five-component solvent system for the separation of three platinum-containing anticancer agents. The initial solvent system exhibited a response of 2.4%; after the solvent composition was modified in 18 steps, the response increased to 99.1%, giving a virtually ideal separation of the three components.

The use of this function is not restricted to the sequential simplex approach. In separating three diuretics, De Spiegeleer and De Moerloose<sup>69</sup> have used its value as a criterion for selecting the optimum mobile phase from a list of 17 solvent systems of fixed composition for which  $R_f$  data were available. This function is a valuable addition to the criteria available for the computer-assisted optimization of planar chromatography and can be used either alone or in conjunction with other criteria for the optimization of more complex mixtures where a response of 100% is most unlikely. For a review on computer-assisted optimization of planar chromatography, see ref 70.

### 3. The Mixture Design Statistical Approach

The introduction of the mixture design statistical approach by Glajch and co-workers<sup>48</sup> is one of the most important additions to the literature of solvent optimization in the past 10 years. It involves the generation of coefficients for a quadratic equation containing between six and ten terms that allows the generation of a chromatographic response surface (i.e., a quantitative estimate of separation quality) for a quaternary mixture of solvents. There has been only one report on the use

of this method in planar chromatography;<sup>62</sup> all other reports are for HPLC. Nevertheless the method has the obvious potential for optimizing the separation of complex mixtures in planar chromatography and for this reason is discussed in some detail in this section. The references to HPLC in this section are illustrative rather than comprehensive; further references can be found in the texts by Schoenmakers<sup>71</sup> and Berridge.<sup>72</sup>

The original report was for reversed-phase chromatography and considered three aqueous solvents of different selectivity (methanol, tetrahydrofuran, and acetonitrile), each tuned to the same overall strength by adjusting the water content, with the result that the entire solvent domain is approximately isoelectrotopropic. The correct solvent strength is estimated in a preliminary experiment by running a suitable gradient. Thus while the selectivity of the system will vary with the solvent composition, the overall retention time (more precisely, the capacity factor range) will remain approximately constant.

A problem may be encountered when this technique is applied to normal-phase separation because "it cannot be assumed that any mixture of two isoelectrotopropic mixtures will yield a new mixture which is in turn isoelectrotopropic".<sup>71</sup> By performing some rather complex calculations, it is possible to ensure that such mixtures are isoelectrotopropic. This statistical method has been applied to normal-phase separation both with<sup>73</sup> and without<sup>74</sup> such calculations.

In its simplest form the equation to generate the chromatographic response surface consists of seven terms:

$$Y = \beta_1 x_1 + \beta_2 x_2 + \beta_3 x_3 + \beta_{12} x_1 x_2 + \beta_{23} x_2 x_3 + \beta_{13} x_1 x_3 + \beta_{123} x_1 x_2 x_3 \quad (14)$$

where  $Y$  is the dependent variable, the  $\beta$ 's are empirically determined coefficients, and the values of  $x$  are volume fractions (i.e.,  $x_1 + x_2 + x_3 = 1.0$ ).  $\beta_1$ ,  $\beta_2$ , and  $\beta_3$  are coefficients referring to each of the single diluted solvents;  $\beta_{12}$ ,  $\beta_{23}$ , and  $\beta_{13}$  are coefficients referring to mixtures of two of the diluted solvents; and  $\beta_{123}$  is the coefficient referring to a mixture of all of the solvents. The coefficients  $\beta_1$ ,  $\beta_2$ , and  $\beta_3$  refer to apices of the ternary solvent triangle;  $\beta_{12}$ ,  $\beta_{23}$ , and  $\beta_{13}$  refer to midpoints on the periphery of the triangle; and  $\beta_{123}$  refers to the midpoint of the triangle. Glajch and co-workers<sup>48</sup> recommend that for reversed-phase separations the first six terms are adequate for predicting a dependent variable; the seventh term can be used to check the validity of the predicted value of the dependent variable. In the initial report<sup>48</sup> either the chromatographic optimization function (COF) or resolution ( $R_s$ ) was used as the dependent variable.

The COF is defined as

$$\text{COF} = \sum A_i \ln \frac{R_i}{R_{id}} + B(t_M - t_L) \quad (15)$$

where  $R_i$  is the resolution of the  $i$ th pair of compounds,  $R_{id}$  is the desired resolution,  $t_M$  and  $t_L$  are the desired and actual retention times, and  $A_i$  and  $B$  are weighting terms, the first of which can be dependent on each pair of compounds. If the values of  $B$  and  $t_M$  are correctly selected, the COF will approach zero from the negative direction as the quality of a separation improves. The COF may be simplified by setting  $B$  equal to zero if analysis time is not considered important and setting

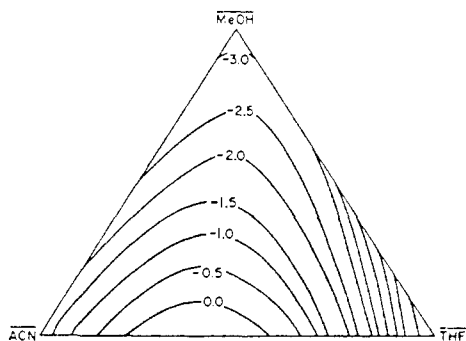

**Figure 3.** COF map for substituted naphthalenes separated by reversed-phase HPLC. The COF values shown are for an  $R_{id} = 1.8$ . Reprinted with permission from ref 48; copyright 1980 Elsevier Science Publishers B.V.

$A_i$  equal to unity if the separation of all solute pairs is considered equally important. Figure 3 illustrates the use of the simplified COF as the dependent variable for optimizing the separation of a mixture of substituted naphthalenes. Its value was measured at the seven defined solvent compositions; eq 14 was then used to draw a COF contour map on the triangular solvent diagram. Solvent compositions within the area between the 0.0 contour and the lower perimeter will yield separations that satisfy the target resolution, which in this example was 1.8. While the COF is not suitable for use as a dependent variable in planar chromatography, there are several functions that can be used for this purpose, including the function introduced by De Spiegeleer and coauthors (function 13) as well as other functions that are discussed in the latter part of this review.

The other dependent variable used in the first report was resolution. This statistical approach allows resolution contours to be constructed for the quaternary solvent domain for each of the possible solute pairs in the mixture. A desired resolution ( $R_s = 1.0$  or  $R_s = 1.5$ ) is selected and those portions of the diagram where  $R_s$  is satisfactory are left unshaded while the area of the diagram that corresponds to an unsatisfactory resolution is shaded. When the composite diagram of all possible solute pairs is constructed, any unshaded area(s) corresponds to that portion of the solvent domain where the desired resolution is attainable. This diagram is equivalent to the physical overlapping of individual diagrams for all possible solute pairs—hence the name overlapping resolution map (ORM). If there is no unshaded area, a less stringent value of resolution may be specified or else another solvent system should be explored. While such a diagram indicates the range of solvent composition where a minimum desired resolution is attainable, it does not indicate the one composition that yields the best overall resolution. In contrast, using an evaluation equation such as the COF can indicate which is the best overall solvent composition. In either of the above approaches the validity of prediction is dependent on using the same column, temperature, and flow rate for obtaining the initial data as well as for the final analytical run. The situation in planar chromatography is similar; the data collection and final run should be performed under identical conditions of humidity (for silica gel or other polar layers), temperature, and development chamber, with all TLC plates being from a given manufactured batch.

The above statistical approach is not limited to a two-dimensional representation of a quaternary solvent system. D'Agostino and coauthors<sup>75</sup> have pointed out that such a range of solvent mixtures may be visualized as a plane intersecting a tetrahedron and that it is necessary to explore the solvent domain as represented by an entire tetrahedron in order to obtain a global optimum for a given quaternary solvent system. If, however, solvents of very low or very high water content are excluded—chromatographic experience predicts that the optimum is most unlikely to occur at these compositions—a truncated pyramid results that requires 12 data points for statistical optimization. The calculations were found to be time-consuming and required 14 h on a personal computer to locate the optimum with a precision of  $\pm 0.1$ – $0.7\%$  in organic modifier and water concentrations.

It should be noted that Glajch and Kirkland<sup>76</sup> were the first to suggest the use of a three-dimensional figure—an irregular prism—to represent the entire quaternary solvent domain. This representation is very relevant to planar chromatography and is the basis of the prisma method, which is discussed in the next section.

The above discussion of the statistical mixture design methods refers entirely to HPLC. Without exception, however, these optimization techniques will be applicable to planar chromatography after some minor modifications to allow for the fact that separation quality is quantified differently in the two techniques and should prove to be equally valuable in defining solvent systems for performing difficult separations by the latter technique. Issaq and co-workers<sup>62</sup> have used the method for defining solvent mixtures in both normal-phase (silica gel) and reversed-phase (either bonded  $C_8$  or  $C_{18}$ ) TLC (as well as HPLC). A ten-term cubic equation was used instead of the seven-term quadratic equation used by Glajch and co-workers. Thus  $R_f$  values are obtained in ten defined solvent compositions, with nine data points being used to define coefficients in the equation while the tenth is used to define goodness of fit. Acetone, methanol, and ethyl acetate, each diluted with chloroform, were used for separating four aflatoxins by normal-phase TLC; aqueous mixtures of acetonitrile, ethoxyethanol, and methanol were used for separating a mixture of four naphthalenes; and aqueous mixtures of acetonitrile, methanol, and tetrahydrofuran were used for separating a five-component mixture consisting of biphenyl, naphthalene, and three anthraquinones—the latter two separations being by reversed-phase chromatography. This approach can obviously be used for separating more complex mixtures. The authors make the point that the optimum of a well-selected system should consist of all three constituent solvents. Occurrence of the optimum along the periphery of the triangular solvent diagram—or worse still, at an apex—indicates that one (or for an apex, two) of the solvents is not contributing to the separation and should be substituted. A valuable aspect of the above paper is that the computer programs used are printed in an appendix.

#### 4. The Prisma Method

This method, which was introduced by Nyiredy and coauthors,<sup>77–80</sup> is a structured trial and error approach



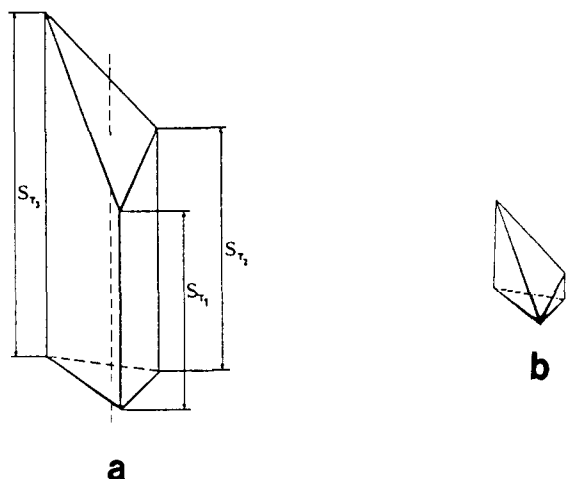

**Figure 4.** (a) The prisma diagram with  $S_{T_1}$ ,  $S_{T_2}$ , and  $S_{T_3}$  representing the strengths of the three undiluted solvents. The vertical dotted line represents the domain of a given selectivity point. (b) The "frustum". Reprinted with permission from ref 77 (copyright 1985 Hüthig Verlag GmbH) and ref 78 (copyright 1986 Elsevier Science Publishers B.V.).

to solvent optimization for systems consisting of between three and five components. While originally introduced for HPLC, it has since been used effectively in planar chromatography and is included in this section of the review because of its sophistication relative to other trial and error methods. The solvent system is represented by a prism as shown in Figure 4a, where  $S_{T_1}$ ,  $S_{T_2}$ , and  $S_{T_3}$  represent the strengths of three solvents, each diluted with a solvent of low strength such as water for reversed-phase chromatography or hexane for normal-phase chromatography. The height above the base represents the strength of a solvent mixture, with the highest point on each of the three parallel edges representing the strength of the corresponding undiluted solvent. This representation is essentially the same as that of Glajch and Kirkland<sup>76</sup> referred to earlier in this review.

In the prisma approach the prism is intersected at the height of its shortest edge ( $S_{T_1}$  in Figure 4a) to yield a regular prism and an irregular "frustum", the latter illustrated in Figure 4b. If a fifth component is required (vide infra), this is represented as a regular base for either the regular prism or the "frustum". The apices of the triangular top surface of the regular prism correspond respectively to the weakest solvent, undiluted, and two stronger solvents, each diluted to the strength of the weakest solvent. The selectivity of solvent compositions on this surface are identified by "selectivity points", which are three-digit coordinates. This surface is considered an isoeluotropic domain, an assumption that is not necessarily correct in normal-phase chromatography, as discussed earlier in this review, but that should not affect the practicality of this technique.

If the solvent strength is too high for a particular separation, solvent triangles of lower strength are defined by intersecting the prism parallel to its base. It is assumed that dilution of a defined solvent mixture (i.e., at a given selectivity point) by the addition of a solvent of zero strength results in a variation in overall strength without significantly altering solvent selectivity. As discussed elsewhere in this review, this statement is not entirely correct; there can be substantial

changes in selectivity values for some, but not all, solvent systems, when a diluent of zero solvent strength is added. In practical terms this inaccurate assumption is of little consequence because an optimum solvent composition is not predicted by computation but rather is found through guided trial and error. Thus any changes in selectivity can easily be compensated for by changing the composition of the three primary solvents.

The apices of the triangular upper surface of the frustum correspond to the strengths of the three primary solvents. This surface is not parallel to the base, and the selectivity points correspond to differences in both selectivity and solvent strength, with the gradient in the latter parameter being dependent on the differences in solvent strength of the three components.

The prisma method has been used in planar chromatography primarily in the normal-phase mode. The initial recommended optimization step for separating a sample mixture is to perform a TLC run in unsaturated chambers with each of ten neat solvents that are selected on the basis of miscibility with hexane and that represent at least one member of each of Snyder's eight selectivity groups. If a solvent is too strong, hexane is added to bring  $R_f$  values of most components into the range 0.2–0.8. Such samples are treated as nonpolar, and the three best solvents, as evaluated by visual inspection of the chromatograms, are used for further optimization, with the regular prism representing the possible range of solvent compositions. Samples that do not require that the solvent be diluted with hexane are considered polar.

The strength of each solvent may be further adjusted by adding water or another polar compound in a low concentration such that the  $R_f$  values of most components are in the range 0.2–0.8. This is useful for both polar and nonpolar samples, even though it will be applicable to the former more frequently. The concentration of this polar component is kept constant throughout the subsequent optimization procedures. Water saturation may be used in place of a constant concentration for solvents of limited miscibility. The three best solvents are then selected for the subsequent optimization.

The subsequent optimization steps with either polar or nonpolar samples are rather similar. In the case of the nonpolar sample the initial solvent composition corresponds to the center of the triangular top face of the regular prism; this composition is then diluted to bring all sample components into the  $R_f$  range 0.2–0.8. The solvent strength is then maintained and a further three chromatograms are run at solvent compositions corresponding to selectivity points near the apices of the triangle, which should be near the extremes of selectivity for the solvent system. These initial runs are then used to choose selectivity points for further chromatograms until the best solvent composition is located. During the final stages of the optimization the solvent strength may be fine tuned by adjusting the hexane concentration. If the best chromatogram does not exhibit adequate resolution, one or more of the primary solvents can be changed and the optimization procedure repeated. If none of the chromatograms at the first four selectivity points (i.e., at the center of the triangle as well as the points near the three apices) is better than the best of the four corresponding chro-

matograms with the previous system, further solvent systems should be investigated.

In the case of polar samples, the upper face of the frustum, consisting of the three undiluted solvents with or without either water or another polar additive, is used. Alternatively, the solvent system can consist of water and two other components; i.e., water can be used as a primary solvent. The optimization is commenced at the same initial selectivity points as with the top face of the regular prism and then proceeds in a manner broadly analogous to that used for nonpolar compounds. As noted earlier, in this case the different selectivity points represent differences not only in selectivity but also in solvent strength. For this reason the authors recommend that smaller increments be used to define selectivity points in those cases where large changes in the chromatograms result from small changes in solvent composition.

The important difference between the statistical mixture design and the prisma methods is that the former yields a computed optimum solvent composition whereas the latter relies on structured trial and error. In HPLC a strong case can be made for the former method. The equilibration time after changing solvent composition can be time-consuming. It is thus attractive to be limited to a defined number of preliminary runs that yield data that can be used to compute an optimum—especially if the whole procedure can be performed automatically. In contrast, for TLC the prisma method is a viable alternative because the time to prepare and evaluate each solvent composition is small and several different compositions can be evaluated simultaneously with several development chambers. OPLC appears intermediate in the attractiveness of the two techniques. It is easier to transfer an optimum solvent system from TLC to OPLC than to HPLC, and a case can be made for optimizing the solvent composition by TLC and then making minor modifications on this composition to find the OPLC optimum.

### III. Strategies for Optimizing Separation in Two-Dimensional Planar Chromatography

#### A. Introduction

One of the most attractive features of planar chromatography is the ability to operate in the two-dimensional mode whereby a plate is developed, the solvent removed, and the plate rotated through 90° and then redeveloped with a second solvent system. If these two solvent systems (hereafter called the two constituent solvent systems) are of approximately the same strength but of optimally different selectivity, then spots will be distributed over the entire plate area and in the ideal case (uniformly distributed spots of the same shape as in one-dimensional planar chromatography) the spot capacity of the two-dimensional system will be the product of the spot capacity of the two constituent one-dimensional systems. If the two constituent solvent systems are of the same selectivity but of different strength, spots will lie along a straight line; if both strength and selectivity are identical, spots will lie along the diagonal.

The best estimate of spot capacity of two-dimensional TLC is most probably that of Guiochon and co-workers,

who have calculated that this should be between 150 and 400;<sup>81</sup> the spot capacity is about 1000 for a hybrid development/elution system using a 10 cm × 10 cm layer<sup>82</sup> where in the first development the solvent reaches the end of the layer while in the second development the spots are eluted from the layer. By analogy the potential spot capacity of two-dimensional OPLC should be at least as great using a high-performance plate in commercially available apparatus where the usable plate dimension is 16 cm × 16 cm. The significance of the above peak capacity is evident when it is considered that Giddings<sup>83</sup> has suggested that a one-dimensional HPLC system would require about ten million theoretical plates to achieve a peak capacity of 2000.

In spite of the attractive spot capacities there are relatively few reports of more than about 30 components being completely separated by two-dimensional TLC as can be seen in a 1983 review by Zakaria and co-workers.<sup>84</sup> The theoretical spot capacities assume uniform spot distribution over the entire layer, which in practice is seldom even approximated. In order to achieve this uniform distribution, it is necessary to select the two constituent solvent systems to be ideally complementary in selectivity, which is a most challenging task. While there are no rules for selecting these two systems, there are computational approaches that allow the best two-dimensional system to be selected from a number of candidate systems. This topic has been included in a recent review<sup>70</sup> on computer-aided techniques in planar chromatography; for the sake of completeness it is included here but is dealt with only briefly, apart from the discussion of ref 85, which was published recently and was not included in the above-mentioned review.

#### B. Conventional Computational Approaches

One computational approach is simply to seek the lowest correlation between single-dimension  $R_f$  values in each of the two constituent solvent systems as has been done by De Spiegeleer and co-workers.<sup>86</sup> The lowest correlation found between any two solvent systems considered by these authors was 0.04, and this allowed all but two of a mixture of fourteen local anesthetics to be separated in the corresponding two-dimensional system.

An alternative approach based on visual inspection of simulated chromatograms was used by Johnson and Nurok<sup>87</sup> for selecting a two-dimensional system for separating steroids by continuous-development TLC. An equation exists<sup>88</sup> for predicting migration distance as a function of plate length, solvent composition, and analysis time in one-dimensional TLC. These migration distance values were used as planar coordinates to specify spot position for each simulated two-dimensional solvent system considered. It was found that the best separations were for normal-phase/reversed-phase systems, which is not surprising due to the large differences in selectivity between these constituent systems. It should be noted that dual-phase TLC plates for developing in the latter mode are commercially available and are coated with a strip of silica gel layer contiguous with a bonded  $C_{18}$  layer or vice versa. Previous reports of sample types separated on such plates include sulfonamides and bile acids.<sup>89</sup>

A more sophisticated approach than the above is to use a mathematical function as a criterion of separation quality; the first to do so were Gonnord and coauthors,<sup>90</sup> who introduced the following two functions for this purpose:

$$D_A = \sum_{i=1}^{k-1} \sum_{j=i+1}^k [(x_i - x_j)^2 + (y_i - y_j)^2] \quad (16)$$

$$D_B = \sum_{i=1}^{k-1} \sum_{j=i+1}^k \frac{1}{(x_i - x_j)^2 + (y_i - y_j)^2} \quad (17)$$

where the values of the distances  $x$  and  $y$  are calculated from  $R_f$  values in each of the two constituent solvent systems. An arbitrary length, equal to a spot width or smaller, is assigned as a separation distance for overlapping spots in order to prevent  $D_B$  from being very large or even undefined. The optimum two-dimensional solvent system will be that which maximizes the value of  $D_A$  or minimizes the value of  $D_B$ , with the latter function being more sensitive to the presence of un-separated pairs than the former. These functions were used to predict the optimum constituent solvent systems for the two-dimensional separation of 19 dinitrophenyl amino acids using published data for the separation of these compounds in ten one-dimensional systems on polyamide layers. A better simulated separation was found in the system selected by  $D_B$  than for the system selected by  $D_A$ .

Other functions used to evaluate two-dimensional separations include the DF and the IDF,<sup>91</sup> which are of the same form as  $D_A$  and  $D_B$ , respectively, but which use distances rather than the squares of distances, and the PRF,<sup>92</sup> which is of a similar form to the simplified COF, discussed earlier in this review.

$$\text{PRF} = \sum_{i=1}^{k-1} \sum_{j=i+1}^k \ln \frac{S_D^{ij}}{S_D^{\text{spec}}} \quad (18)$$

$S_D^{ij}$  is the actual spot separation, and  $S_D^{\text{spec}}$  is the desired spot separation. All solute pairs with  $S_D^{ij} > S_D^{\text{spec}}$  are assigned a value of  $S_D^{\text{spec}}$  and have a zero contribution to the PRF.

These functions have been used to evaluate 171 possible two-dimensional solvent systems for separating a mixture of 15 steroids.<sup>85</sup> These systems included 13 candidate solvent systems and four stationary phases (silica gel, bonded  $C_2$ , bonded  $C_{18}$ , and bonded diphenyl). A total of 1681 simulated chromatograms were computer evaluated for each of the possible 171 systems in order to obtain an optimum for the entire two-dimensional solvent domain. These optimum values were then used to rank the different systems. In addition, the best of the 1681 simulated chromatograms for each two-dimensional system was printed in order to allow ranking based on visual evaluation.

It was found that there is generally a good agreement between the ranking criteria but that in certain instances there is a divergence, which the authors explain in terms of how these criteria are defined. The best agreement was for the four systems highest ranked by the IDF, which are all ranked among at least the highest 7% of systems by any of the other criteria used. It was found that, with one exception, the four systems respectively ranked highest by either the IDF, PRF, or

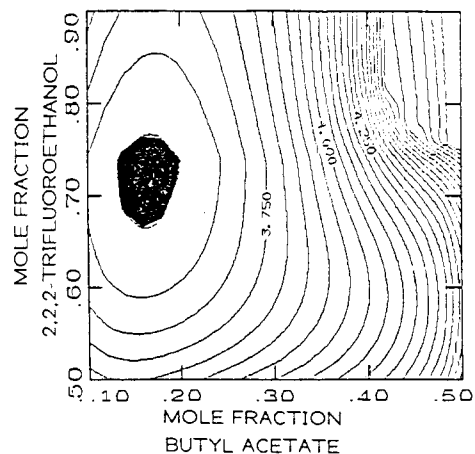
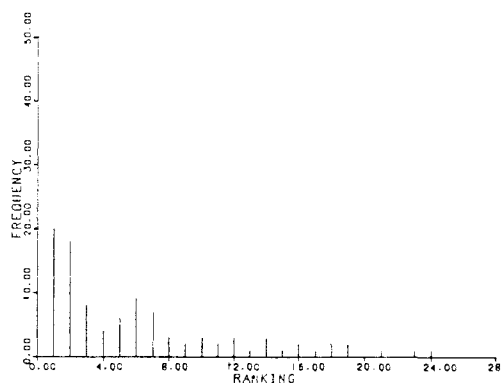

**Figure 5.** Two-dimensional contour diagram for the separation of 15 steroids on a dual-phase plate using butyl acetate/toluene on silica gel and aqueous 2,2,2-trifluoroethanol on bonded  $C_{18}$  as the constituent solvent systems. Reprinted with permission from ref 93; copyright 1987 Hüthig Verlag GmbH.

DF are among the highest 5% of the 171 solvent systems as judged by visual evaluation. Thus this purely automated method of chromatogram evaluation appears valid; it enables the most promising solvent systems, as well as layer types, to be rapidly identified from a number of possibilities sufficiently large to be impossible to evaluate experimentally in a rigorous manner. Preliminary data for the relevant one-dimensional solvent systems must, of course, be available. It was found that of the 13 binary solvents considered, butyl acetate/toluene on silica gel and aqueous 2,2,2-trifluoroethanol on bonded  $C_{18}$  were each represented five times as constituents of the best 11 two-dimensional solvent systems—i.e., these two binary solvents comprised 45% of the best represented constituent solvents in this study. It is interesting to note that neither of these two solvents are normally considered as being solvents of particular selectivity in either planar chromatography or HPLC. The study also provided insight into layer types for separating this class of compounds. Eight of the best eleven simulated separations were on dual-phase plates consisting of a silica gel strip contiguous to bonded  $C_{18}$ . In contrast, two-dimensional separations in which both developments were on bonded phase were generally poor, irrespective of which bonded ligands were involved.

Computer simulation is a useful tool for identifying promising systems but there is no guarantee that experimental and simulated chromatograms will be in agreement due to either changes in experimental conditions (e.g., humidity, age of TLC plate) or due to solvent demixing. Published examples show good agreement in overall spot pattern but some differences in actual spot positions.<sup>85,91</sup>

Another use of computer simulation is in the construction of contour diagrams of the two-dimensional solvent domain.<sup>93</sup> An example of such a diagram for the separation of a mixture of steroids is shown in Figure 5, where the dependent variable is the value of the IDF in  $\text{mm}^{-1}$  and the two independent variables are the mole fractions of the strong solvent in each of the constituent solvent systems. The darkened area indicates the optimum solvent composition whereas the solvent composition yielding the poorest separation is in the upper right-hand corner. The diagram indicates



**Figure 6.** Frequency of solvent ranking according to the IDF for subsets of six steroids. The solvent system is the same as in Figure 5. Reprinted with permission from ref 92; copyright 1987 American Chemical Society.

that the optimum is broad, but that there is a region of the solvent domain where separation deteriorates very rapidly with small changes of solvent composition. Such diagrams allow the comparison of different solvent systems and of different evaluation criteria.

### C. The Statistical Approach

An approach such as that described above for two-dimensional TLC allows the best solvent system(s) to be selected for separating a given set of solutes. It does not however provide information as to which would be the best solvent system if either a different set of solutes of the same chemical class were considered or the size of the solute set were varied. In principle, this information could be obtained by separating many different mixtures of a given chemical class, in which both the number of solutes and their identity are varied, but for obvious reasons this is an impractical approach. An alternative approach<sup>92</sup> is to obtain data for a set of solutes and to then compute how solvent ranking varies with variations in both the identity and the size of subsets of this solute set. The number of subsets that needs to be considered can be very large, and it is usually practical to evaluate only a small fraction of these, using computer simulation and a function such as the IDF—hence the statistical nature of the technique. The data may be presented as a histogram that shows the frequency of ranking according to the IDF (or any other suitable criterion) of a particular solvent system for separating subsets of a given size. Figure 6 shows such a histogram for the separation of subsets of 6 of a set of 15 steroids using the system butyl acetate/toluene (silica gel)—aqueous 2,2,2-trifluoroethanol (bonded C<sub>18</sub>). In this particular study<sup>92</sup> the latter had the highest overall ranking out of 28 solvent systems. Nevertheless, it is seen that it is the highest ranked system for only 20 of the 100 subsets considered and in fact is ranked only 24th for separating one of these subsets. This illustrates the difficulty of predicting the “best” solvent system for separating a mixture of solutes, even when all are of the same chemical class. The corresponding histograms for subsets of 10 steroids shows a narrower frequency distribution, with the above solvent system being highest ranked for 49 of the 100 subsets.

The statistical method also allows an estimation of the probability that a given solvent system will be the best system for separating any subset (of the specified

set) of a given size or that the separation of such a subset will be of a quality as defined by the value of a function such as the PRF. The statistical approach has also been used for one-dimensional planar chromatography<sup>94</sup> and should be equally applicable to HPLC.

### References

- (1) Geiss, F. *The Fundamentals of Thin Layer Chromatography (Planar Chromatography)*; Hüthig Verlag: Heidelberg, 1987.
- (2) Fried, B.; Sherma, J. *Thin-Layer Chromatography. Techniques and Applications*; Marcel Dekker: New York, 1986.
- (3) Poole, C. F.; Schuette, S. A. “High Performance Thin-Layer Chromatography”. In *Contemporary Practice of Chromatography*; Elsevier Scientific Publishing Co.: Amsterdam, 1985; Chapter 9, p 619.
- (4) Touchstone, J. C.; Dobbins, M. F. *Practice of Thin Layer Chromatography*; Wiley: New York, 1983.
- (5) Geiss, F. *The Fundamentals of Thin Layer Chromatography (Planar Chromatography)*; Hüthig Verlag: Heidelberg, 1987; p 398.
- (6) Giddings, J. C.; Stewart, G. H.; Ruoff, A. L. *J. Chromatogr.* **1960**, *3*, 239.
- (7) Geiss, F. *The Fundamentals of Thin Layer Chromatography (Planar Chromatography)*; Hüthig Verlag: Heidelberg, 1987; p 31.
- (8) Brenner, M.; Niederwieser, A.; Pataki, G.; Weber, R. In *Thin-Layer Chromatography*; Stahl, E., Ed.; Academic Press: New York, 1965; p 107.
- (9) Geiss, F. *J. Planar Chromatogr.* **1988**, *1*, 102.
- (10) Schoenmakers, P. J. *Optimization of Chromatographic Selectivity*; Elsevier: Amsterdam, 1986.
- (11) Snyder, L. R. *Principles of Adsorption Chromatography*; Marcel Dekker: New York, 1968; p 19.
- (12) Guiochon, G.; Bressolle, F.; Siouffi, A. *J. Chromatogr. Sci.* **1979**, *17*, 368.
- (13) Guiochon, G.; Siouffi, A. *J. Chromatogr. Sci.* **1978**, *16*, 598.
- (14) Kaiser, R. E. In *HPTLC High Performance Thin-Layer Chromatography*; Zlatkis, A., Kaiser, R. E., Eds.; Elsevier: Amsterdam, 1976; p 15.
- (15) Blome, J. In *HPTLC High Performance Thin-Layer Chromatography*; Zlatkis, A., Kaiser, R. E., Eds.; Elsevier: Amsterdam, 1976; p 39.
- (16) Geiss, F. *The Fundamentals of Thin Layer Chromatography (Planar Chromatography)*; Hüthig Verlag: Heidelberg, 1987; p 125.
- (17) Snyder, L. R. *Principles of Adsorption Chromatography*; Marcel Dekker: New York, 1968; p 20.
- (18) Jänchen, D. In *HPTLC High Performance Thin-Layer Chromatography*; Zlatkis, A., Kaiser, R. E., Eds.; Elsevier: Amsterdam, 1976; p 129.
- (19) Perry, J. A. *J. Chromatogr.* **1979**, *165*, 117.
- (20) Soczewinski, E.; Golkiewicz, W. *Chromatographia* **1973**, *6*, 269.
- (21) Jandera, P.; Churáček, J. *J. Chromatogr.* **1974**, *91*, 207.
- (22) Soczewinski, E.; Golkiewicz, W.; Szumilo, H. *J. Chromatogr.* **1969**, *45*, 1.
- (23) Soczewinski, E.; Golkiewicz, W.; Markowski, W. *Chromatographia* **1975**, *8*, 13.
- (24) Nurok, D.; Becker, R. M.; Sassic, K. A. *Anal. Chem.* **1982**, *54*, 1955.
- (25) Tecklenburg, R. E., Jr.; Becker, R. M.; Johnson, E. K.; Nurok, D. *Anal. Chem.* **1983**, *55*, 2196.
- (26) Tecklenburg, R. E., Jr.; Maidak, B. L.; Nurok, D. *J. High Res. Chromatogr. Chromatogr. Commun.* **1983**, *6*, 627.
- (27) Johnson, E. K.; Wenning, M. J.; Tecklenburg, R. E., Jr.; Nurok, D. *J. High Res. Chromatogr. Chromatogr. Commun.* **1986**, *9*, 285.
- (28) Johnson, E. K.; Nurok, D., unpublished results.
- (29) Snyder, L. R. *J. Chromatogr.* **1974**, *92*, 223.
- (30) Schoenmakers, P. J.; Billiet, H. A. H.; de Galan, L. *Chromatographia* **1982**, *15*, 205.
- (31) Johnson, B. P.; Khaledi, M. G.; Dorsey, J. G. *Anal. Chem.* **1986**, *58*, 2354.
- (32) Cheong, W. J.; Carr, P. W. *Anal. Chem.* **1988**, *60*, 820.
- (33) Snyder, L. R. *Principles of Adsorption Chromatography*; Marcel Dekker: New York, 1968; p 189.
- (34) Geiss, F. *The Fundamentals of Thin Layer Chromatography (Planar Chromatography)*; Hüthig Verlag: Heidelberg, 1987; p 250.
- (35) Schoenmakers, P. J. *Optimization of Chromatographic Selectivity*; Elsevier: Amsterdam, 1986; p 76.
- (36) Snyder, L. R. *Principles of Adsorption Chromatography*; Marcel Dekker: New York, 1968; p 208.
- (37) Snyder, L. R.; Glajch, J. L. *J. Chromatogr.* **1981**, *214*, 1.
- (38) Snyder, L. R.; Glajch, J. L. *J. Chromatogr.* **1981**, *214*, 21.
- (39) Snyder, L. R. *Principles of Adsorption Chromatography*; Marcel Dekker: New York, 1968; p 191.
- (40) Snyder, L. R. *J. Chromatogr.* **1974**, *92*, 223.

- (41) Snyder, L. R. *J. Chromatogr. Sci.* 1978, 16, 223.
- (42) Rohrschneider, L. *Anal. Chem.* 1973, 45, 1241.
- (43) Poppe, H.; Slaats, E. H. *Chromatographia* 1981, 14, 89.
- (44) Antle, P. E. *Chromatographia* 1982, 15, 277.
- (45) Glajch, J. L.; Kirkland, J. J.; Snyder, L. R. *J. Chromatogr.* 1982, 238, 269.
- (46) Snyder, L. R.; Glajch, J. L. *J. Chromatogr.* 1981, 214, 1.
- (47) Snyder, L. F.; Glajch, J. L.; Kirkland, J. J. *J. Chromatogr.* 1981, 218, 299.
- (48) Glajch, J. L.; Kirkland, J. J.; Squire, K. M.; Minor, J. M. *J. Chromatogr.* 1980, 199, 57.
- (49) Snyder, L. R.; Kirkland, J. J. *Introduction to Modern Liquid Chromatography*, 2nd ed.; Wiley-Interscience: New York, 1979; p 257.
- (50) Lewis, J. J.; Rogers, L. B.; Pauls, R. E. *J. Chromatogr.* 1983, 165, 39.
- (51) West, S. D. *J. Chromatogr. Sci.* 1987, 25, 122.
- (52) Snyder, L. R.; Dolan, J. W.; Gant, J. R. *J. Chromatogr.* 1979, 165, 3.
- (53) Halpaap, H. In *HPTLC High Performance Thin Layer Chromatography*; Zlatkis, A., Kaiser, R. E., Eds.; Elsevier: Amsterdam, 1976; p 126.
- (54) Snyder, L. R.; Kirkland, J. J. *Introduction to Modern Liquid Chromatography*, 2nd ed.; Wiley-Interscience: New York, 1979; p 248.
- (55) Geiss, F. *The Fundamentals of Thin Layer Chromatography (Planar Chromatography)*; Hüthig Verlag: Heidelberg, 1987; p 378.
- (56) Ripphahn, J.; Halpaap, H. In *HPTLC High Performance Thin Layer Chromatography*; Zlatkis, A., Kaiser, R. E., Eds.; Elsevier: Amsterdam, 1976; p 189.
- (57) Geiss, F. *The Fundamentals of Thin Layer Chromatography (Planar Chromatography)*; Hüthig Verlag: Heidelberg, 1987; p 279.
- (58) Saunders, D. L. *Anal. Chem.* 1974, 46, 470.
- (59) Nurok, D.; Richard, M. J. *Anal. Chem.* 1981, 53, 563.
- (60) Nurok, D.; Becker, R. M.; Richard, M. J.; Cunningham, P. D.; Gorman, W. B.; Bush, C. L. *J. High Res. Chromatogr. Chromatogr. Commun.* 1982, 5, 373.
- (61) Julian, L. A.; Uhegbu, C. E.; Nurok, D., unpublished results.
- (62) Issaq, H. J.; Klose, J. R.; McNitt, K. L.; Haky, J. E.; Muschik, G. M. *J. Liq. Chromatogr.* 1981, 4, 2091.
- (63) Shavers, C. L.; Parsons, M. L.; Deming, S. N. *J. Chem. Educ.* 1979, 56, 307.
- (64) Sabaté, L. G.; Tomas, X. *J. High Res. Chromatogr. Chromatogr. Commun.* 1984, 7, 104.
- (65) Turina, S. In *Planar Chromatography*; Kaiser, R. E., Ed.; Hüthig Verlag: Heidelberg, 1986; p 15.
- (66) De Spiegeleer, B. M. J.; De Moerloose, P. H. M.; Slegers, G. A. S. *Anal. Chem.* 1987, 59, 62.
- (67) Morgan, S. L.; Deming, S. N. *J. Chromatogr.* 1975, 112, 267.
- (68) Deming, S. N.; Bower, J. G.; Bower, K. D. *Advances in Chromatography*; Giddings, J. C., Grushka, E., Cazes, J., Brown, P. R., Eds.; Marcel Dekker: New York, 1984; Vol. 24, p 35.
- (69) De Spiegeleer, B. M. J.; De Moerloose, P. *J. Planar Chromatogr.* 1988, 1, 61.
- (70) Nurok, D. *LC-GC Mag.* 1988, 6, 310.
- (71) Schoenmakers, P. J. *Optimization of Chromatographic Selectivity*; Elsevier: Amsterdam, 1986; p 216.
- (72) Berridge, J. C. *Techniques for the Automated Optimization of HPLC Separations*; Wiley-Interscience: Chichester, 1985; p 70.
- (73) Glajch, J. L.; Kirkland, J. J.; Snyder, L. R. *J. Chromatogr.* 1982, 238, 269.
- (74) Antle, P. E. *Chromatographia* 1982, 15, 277.
- (75) D'Agostino, G.; Mitchell, F.; Castagnetta, L.; O'Hare, M. J. *J. Chromatogr.* 1984, 305, 13.
- (76) Glajch, J. L.; Kirkland, J. J. *Anal. Chem.* 1982, 54, 2593.
- (77) Nyiredy, Sz.; Meier, B.; Erdelmeier, C. A. J.; Sticher, O. *J. High Res. Chromatogr. Chromatogr. Commun.* 1985, 8, 186.
- (78) Dallenbach-Toelke, K.; Nyiredy, Sz.; Meier, B.; Sticher, O. *J. Chromatogr.* 1986, 365, 63.
- (79) Dallenbach-Toelke, K.; Nyiredy, Sz.; Meszaros, S. Y.; Sticher, O. *J. High Res. Chromatogr. Chromatogr. Commun.* 1987, 10, 362.
- (80) Nyiredy, Sz. "Application of the 'Prisma' Model for the Selection of Eluent Systems in Overpressured Layer Chromatography", Labor MIM, Budapest, 1987.
- (81) Guiochon, G.; Connord, M.-F.; Siouffi, A.; Zakaria, M. *J. Chromatogr.* 1982, 250, 1.
- (82) Guiochon, G.; Beaver, L. A.; Gonnord, M.-F.; Siouffi, A. M.; Zakaria, M. *J. Chromatogr.* 1983, 255, 415.
- (83) Giddings, J. C. *J. High Res. Chromatogr. Chromatogr. Commun.* 1987, 10, 319.
- (84) Zakaria, M.; Gonnord, M.-F.; Guiochon, G. *J. Chromatogr.* 1983, 271, 127.
- (85) Habibi-Goudarzi, S.; Ruterbories, K. J.; Steinbrunner, J. E.; Nurok, D. *J. Planar Chromatogr.* 1988, 1, 161.
- (86) De Spiegeleer, B.; Van den Bossche, W.; De Moerloose, P.; Massart, D. *Chromatographia* 1987, 23, 407.
- (87) Johnson, E. K.; Nurok, D. *J. Chromatogr.* 1984, 302, 135.
- (88) Nurok, D.; Techlenburg, R. E.; Maidak, B. L. *Anal. Chem.* 1984, 56, 293.
- (89) Sherma, J. *Practice and Applications of Thin Layer Chromatography on Whatman KC<sub>18</sub> Reversed Phase Plates*; TLC Technical Series; Whatman Chemical Separation Inc.; Clifton, NJ, 1982.
- (90) Gonnord, M.-F.; Levi, F. J.; Guiochon, G. *J. Chromatogr.* 1983, 264, 1.
- (91) Steinbrunner, J. E.; Johnson, E. K.; Habibi-Goudarzi, S.; Nurok, D. *Planar Chromatography*; Kaiser, R. E., Ed.; Hüthig Verlag: Heidelberg, 1986; Vol. 1, p 239.
- (92) Nurok, D.; Habibi-Goudarzi, S.; Kleyle, R. *Anal. Chem.* 1987, 59, 2424.
- (93) Steinbrunner, J. E.; Malik, D. J.; Nurok, D. *J. High Res. Chromatogr. Chromatogr. Commun.* 1987, 10, 560.
- (94) Risley, D.; Habibi-Goudarzi, S.; Nurok, D., unpublished results.